

A13-OLinuXino and A13-OLinuXino-WIFI

Open-source single-board
Android 4.0 mini-computer

USER'S MANUAL

Revision F, March 2013
Designed by OLIMEX Ltd, 2012



All boards produced by Olimex LTD are ROHS compliant

DISCLAIMER

© 2012 Olimex Ltd. Olimex®, logo and combinations thereof, are registered trademarks of Olimex Ltd. Other product names may be trademarks of others and the rights belong to their respective owners.

The information in this document is provided in connection with Olimex products. No license, express or implied or otherwise, to any intellectual property right is granted by this document or in connection with the sale of Olimex products.

The Hardware project is released under the Creative Commons Attribution-Share Alike 3.0 United States License. You may reproduce it for both your own personal use, and for commercial use. You will have to provide a link to the original creator of the project <http://www.olimex.com> on any documentation or website. You may also modify the files, but you must then release them as well under the same terms. Credit can be attributed through a link to the creator website: <http://www.olimex.com>

The software is released under GPL.

It is possible that the pictures in this manual differ from the latest revision of the board.

The product described in this document is subject to continuous development and improvements. All particulars of the product and its use contained in this document are given by OLIMEX in good faith. However all warranties implied or expressed including but not limited to implied warranties of merchantability or fitness for purpose are excluded. This document is intended only to assist the reader in the use of the product. OLIMEX Ltd. shall not be liable for any loss or damage arising from the use of any information in this document or any error or omission in such information or any incorrect use of the product.

This evaluation board/kit is intended for use for engineering development, demonstration, or evaluation purposes only and is not considered by OLIMEX to be a finished end-product fit for general consumer use. Persons handling the product must have electronics training and observe good engineering practice standards. As such, the goods being provided are not intended to be complete in terms of required design-, marketing-, and/or manufacturing-related protective considerations, including product safety and environmental measures typically found in end products that incorporate such semiconductor components or circuit boards.

Olimex currently deals with a variety of customers for products, and therefore our arrangement with the user is not exclusive. Olimex assumes no liability for applications assistance, customer product design, software performance, or infringement of patents or services described herein.

THERE IS NO WARRANTY FOR THE DESIGN MATERIALS AND THE COMPONENTS USED TO CREATE OLINUXINO. THEY ARE CONSIDERED SUITABLE ONLY FOR OLINUXINO.

Table of Contents

DISCLAIMER.....	2
CHAPTER 1: OVERVIEW.....	5
1. Introduction to the chapter.....	5
1.1 Features.....	5
1.2 Target market and purpose of the board.....	6
1.3 Board variants.....	6
1.4 Organization.....	6
CHAPTER 2: SETTING UP THE OLINUXINO BOARD.....	7
2. Introduction to the chapter.....	7
2.1 Electrostatic warning.....	7
2.2 Requirements.....	7
2.3 Powering the board.....	8
2.4 Prebuilt software.....	9
2.5 Button functions in Android.....	10
2.6 How we configured the Android image.....	10
2.6.1. Getting the Android SDK tools.....	10
2.6.2. Adding information for the board in the Linux.....	10
2.6.3. Installing the SDK tools.....	11
2.6.4. Connecting the A13-OLinuXino.....	12
2.6.5. Downloading the default config file and script tool.....	13
2.6.6. Applying the script and uploading the confing.....	13
2.6.7. Restarting the A13-OLinuXino.....	13
2.7 Configuration of hardware in the Debian image.....	13
CHAPTER 3: A13-OLINUXINO BOARD DESCRIPTION.....	14
3. Introduction to the chapter.....	14
3.1 Layout (top view).....	14
CHAPTER 4: THE ALLWINNER A13 MICROCONTROLLER.....	15
4. Introduction to the chapter.....	15
4.1 The microcontroller.....	15
4.2 Block diagram.....	17
CHAPTER 5: CONTROL CIRCUITY.....	18
5. Introduction to the chapter.....	18
5.1 Reset.....	18
5.2 Clocks.....	18
5.3 Power supply circuit.....	18
CHAPTER 6: CONNECTORS AND PINOUT.....	19
6. Introduction to the chapter.....	19
6.1 Communication with the A13.....	19
6.1.1 USB communication.....	19

6.1.2 UART1 interface.....	20
6.2 SD/MMC slot.....	21
6.3 UEXT module.....	22
6.4 GPIO-1 (General Purpose Input/Output) 10pin connector	23
6.5 GPIO-2 (General Purpose Input/Output) 40pin connector	23
6.6 LCD_CON 40pin connector	25
6.7 PWR Jack.....	26
6.8 Headphones and microphone connector.....	26
6.9 Battery connector.....	27
6.7 VGA video connector.....	27
6.8 Jumper description.....	28
6.8.1 CE_NAND_E.....	28
6.8.2 3.3V_OPTION, 1.5V_E.....	28
6.8.3 5V_E.....	28
6.8.4 HOST_EN, 5V_E_WIFI, WIFI-3.3V/5V_USB.....	28
6.9 Additional hardware components.....	28
CHAPTER 7: SCHEMATICS.....	30
7. Introduction to the chapter.....	30
7.1 Eagle schematic.....	30
7.2 Physical dimensions.....	32
CHAPTER 8: REVISION HISTORY AND SUPPORT.....	33
8. Introduction to the chapter.....	33
8.1 Document revision.....	33
8.2 Board revision.....	35
8.3 Useful web links and purchase codes.....	36
8.4 Product support.....	37

CHAPTER 1: OVERVIEW

1. Introduction to the chapter

Thank you for choosing the OLinuXino single board computer from Olimex! This document provides a user's guide for the Olimex OLinuXino board. As an overview, this chapter gives the scope of this document and lists the board's features. The document's organization is then detailed. The OLinuXino development board enables code development of applications running on the microcontroller A13, manufactured by Allwinner Technology from China.

OLinuXino is an open-source, open-hardware project and all documentation is available to the customer.

1.1 Features

- A13 Cortex A8 processor at 1GHz, 3D Mali400 GPU
- 512 MB RAM
- 6-16VDC input power supply, noise immune design
- 3 + 1 USB Host, 3 available for users 1 for (optional) WIFI RTL8188CU 802.11n 150Mbit module on board
- 1 USB OTG which can power the board
- SD-card connector for booting the Linux image
- (optional) 4GB NAND flash
- VGA video output – 800 x 600 resolution
- LCD signals available on connector so you still can use LCD if you disable VGA/HDMI
- Audio Output
- Microphone input
- RTC PCF8536 on board for real time clock and alarms
- 5 Keys on board for android navigation
- UEXT connector for connecting additional UEXT modules like Zigbee, Bluetooth, Relays, etc
- GPIO connector with 68/74 pins and these signals : 17 for adding NAND flash; 22 for connecting LCDs; 20+4 including 8 GPIOs which can be input, output, interrupt sources; 3x I2C; 2x UARTs; SDIO2 for connecting SDcards and modules; 5 system pins: +5V, +3.3V, GND, RESET, NMI
- (Optional low cost 7" LCD with touchscreen)

1.2 Target market and purpose of the board

The boards from the OLinuXino family are easy to setup and powerful. They are suitable for embedded programming enthusiasts, Linux and Android gadget fans and also professionals (since its low cost makes it very good solution for application orientated embedded systems). The main usage of the board is software embedded development without the urge of understanding perfectly the hardware.

The strong points of the boards are the processor speed, the mobility of the board and the low ratio price to productivity.

Customers have full access to the technical documentation of the board. The software is released under General Purpose License and the board is considered open-hardware.

1.3 Board variants

There are two major board variants. According to the names: A13-OLinuXino and A13-OLinuXino-MICRO.

The base model has also two flavors: A13-OLinuXino and A13-OLinuXino-WIFI. The first one is the base model that goes without any operating system image on board, while the second has two additional components – a WIFI module on the board and NAND memory with stored Android image.

The information on A13-OLinuXino-Micro will be added at a later time but so far the board is most likely to differ from the base A13-OLinuXino by having only 1 USB host, 1 USB OTG, no power connector, no NAND memory, no WIFI, no audio out connector, less buttons.

1.4 Organization

Each section in this document covers a separate topic, organized as follow:

- Chapter 1 is an overview of the board usage and features
- Chapter 2 provides a guide for quickly setting up the board and software notes
- Chapter 3 contains the general board diagram and layout
- Chapter 4 describes the component that is the heart of the board: the A13 – Allwinner processor
- Chapter 5 is an explanation of the control circuitry associated with the microcontroller to reset. Also shows the clocks on the board
- Chapter 6 covers the connector pinout, peripherals and jumper description
- Chapter 7 provides the schematics
- Chapter 8 contains the revision history, useful links and support information

CHAPTER 2: SETTING UP THE OLINUXINO BOARD

2. Introduction to the chapter

This section helps you set up the OLinuXino development board for the first time. Please consider first the electrostatic warning to avoid damaging the board, then discover the hardware and software required to operate the board.

The procedure to power up the board is given, and a description of the default board behavior is detailed.

2.1 Electrostatic warning

OLinuXino is shipped in a protective anti-static package. The board must not be exposed to high electrostatic potentials. A grounding strap or similar protective device should be worn when handling the board. Avoid touching the component pins or any other metallic element.

2.2 Requirements

In order to set up the OLinuXino optimally, the following items are required:

- 6V to 16V, 6W required (6V @ 1A or 16V @ 0.4A) – for optimal power
- LCD (preferably with touchscreen panel) display for the LCD_CON OR TV monitor with RGB port
- A USB mouse – if you use touchscreen LCD you might skip the mouse

Additional items include:

- USB keyboard – for convenience with text input
- USB-SERIAL-CABLE-F – for serial communication with UART1 connector
- USB-MINI-CABLE – for connecting with the USB OTG and being able to firmware update of power A13-OLinuXino
- Wireless internet connectivity or USB modem – for browser access and access to the Android market

Some of the suggested items can be purchased by Olimex, for instance:

SY0612E - power supply adapter 12V/0.5A for A13-OLinuXino

USB-SERIAL-CABLE-F - USB serial console cable female

USB-MINI-CABLE – standard USB type A to USB type mini cable

A 7" LCD display with optional touch screen panel is available for purchase also:

<https://www.olimex.com/Products/OLinuXino/A13/A13-LCD7/>

<https://www.olimex.com/Products/OLinuXino/A13/A13-LCD7-TS/>

Note that if you wish to use one of the LCD displays mentioned above you need to upload different Android image – configured for 480x800 screen resolution.

2.3 Powering the board

There are three possible ways of powering A13-OLinuXino – via external supply using the power jack, via a battery using the battery connector or via the USB OTG connector. Depending on your preferred way of powering A13-OLinuXino you might need additional hardware.

The preferred way of powering board is via the PWR jack with 6Vdc to 16Vdc with a power of 6W (e.g. 6Vx1A to 16Vx0.4A). This will make the board fully powered and able to power all the peripherals connected to it.

When powered by the typical 3.7V Lithium-polymer battery the board will be fully functional and you will be able to operate with most of the peripherals. However when using all three USB-A connectors and an LCD connected to the LCD_con it might cause flickering and not sufficient power. If you suspect the power is not enough for the peripherals you have connected use the PWR jack.

The board can be also powered by the USB OTG connector (mini USB standard) but the voltage provided is not enough to power a possible LCD connected to the LCD_con. However, this power option is capable of driving the board when using external display connected to the VGA connector.

If you have a standard LCD display connected to LCD_con, Android and WIFI running the typical consumption is between 150mA and 350mA depending on the current load. While the board is in stand-by mode it consumes a minimum of 60mA. All the three approximate values above were taken when I applied 12V to the board.

Important! Avoid disconnecting the power supply while Android or Linux is running, since that might corrupt the operating system and you will need to install the OS again (for Android install instructions check chapter 2.6. Use the PWR_BUT before disconnecting the supply.

If the board has entered power-down state you can bring it back without restart using the PWR_BUT.

For the European customers we sell a power supply adapter 12V/0.5A – **SY0612E**. We also sell USB OTG to USB type A cables if you lack such.

2.4 Prebuilt software

The A13-OLinuXino-WIFI board comes with Android 4.0 ready to use. The default settings of the software are followed.

Note that the A13-OLinuXino (standard version without WIFI) lacks NAND memory and there isn't OS uploaded on the shipped boards (no Android).

How we have installed the software? We have configured an Android image with settings suitable for A13-OLinuXino. Then using LiveSuit tools we uploaded the image to the board. To activate A13 bootloader do as follows: run Livesuit, disconnect the power supply and USB cable, then press HOME button, apply power supply, attach USB cable and release the button, Livesuit will detect the bootloader and will ask which file to program to the NAND flash. The image will be available for users to try and tweak the settings. You can find an image with the view of the progress window in LiveSuit:

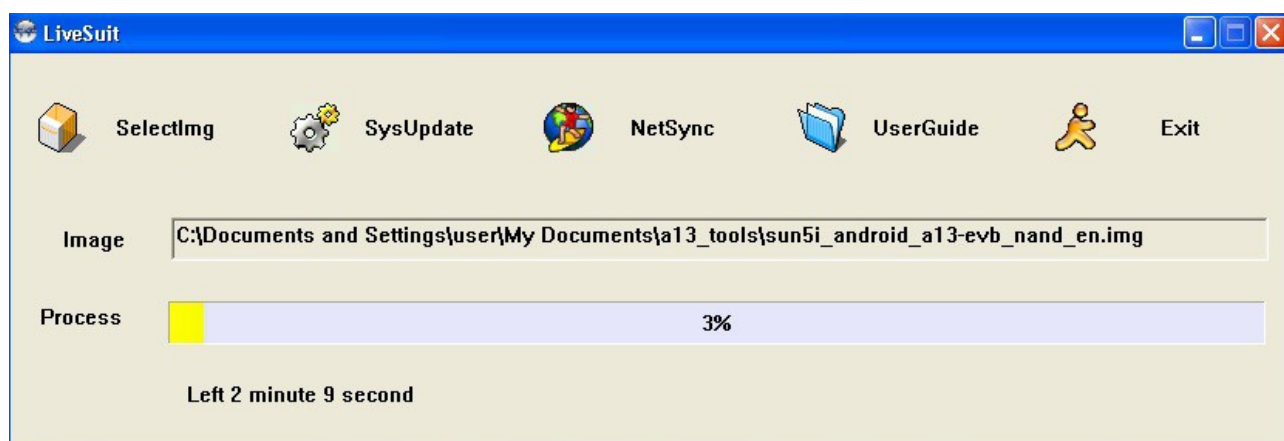

Download links to all available images (and tools needed) can be found at the A13-OLinuXino wiki page: <https://www.olimex.com/wiki/A13-OLinuXino>.

Helpful information about the Android and Linux images can be found at the OLIMEX forums.

2.5 Button functions in Android

The following buttons represent functions in the Android:

PWR_BUTTON – used to wake the board from stand-by

HOME – shows the home screen; note that HOME is also used to enter bootloader mode for firmware update

ENTER – to select a choice

MENU – brings up the main menu

VOL+ – increases the volume

VOL- – lowers the volume

For more information on the button functions check the Android documentation.

Note that **RESET** button will perform a hardware reset of the board, not controlled by the OS.

2.6 How we configured the Android image

This is a detailed explanation of how we got to tweak the Android image configuration files. It is worth mentioning that we used Ubuntu with Linux Kernel 3.2 for the steps below.

2.6.1. Getting the Android SDK tools

Download the Android SDK tools for Linux from: <http://developer.android.com/sdk/index.html>

Note that you have to click “Other platforms” and get the one for Linux. Then you extract it:

```
tar zxfv android-sdk_r20.0.3-linux.tgz
```

Note that the above line would vary depending on the version you have downloaded (by the time of writing 20.0.3 was the latest one).

2.6.2. Adding information for the board in the Linux

Create the following file:

```
.../etc/udev/rules.d/70-android.rules
```

and add the following line inside:

```
SUBSYSTEM=="usb_device", SYSFS{idVendor}=="18d1", MODE="0666"
```

then we save the file and change its properties with `chmod +x 70-android.rules` and reboot the computer.

2.6.3. Installing the SDK tools

Navigate to the folder where we extracted the tools (folder tools) in point 1 and start it:

```
./android
```

From the check boxes select to install Android SDK Tools, Android SDK Platform Tools and Android 4.0 API (check the screenshot)

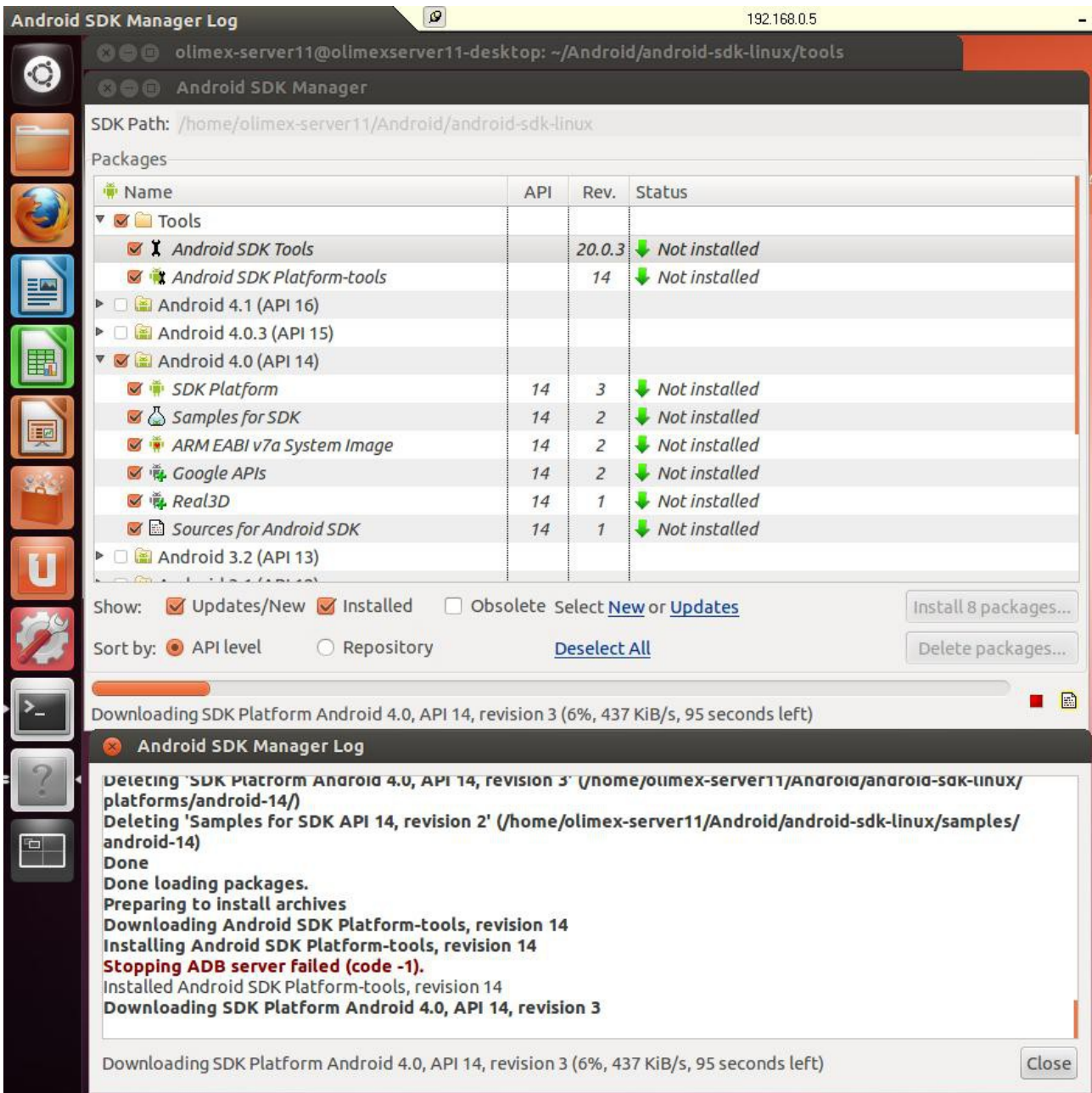

2.6.4. Connecting the A13-OLinuXino

Power the A13-OLINUXINO. Now connect the miniUSB to the board and wait a bit for the USB to enumerate.

After the tools are installed we navigate to “platform-tools” folder located in the directory of the tools (where we extracted in point 1), then we enter:

```
./adb devices
```

which will show us the list of the available devices. The output should would like:

```
List of devices attached
20080411 device
```

However if we get “*bash: ./adb: No such file or directory*” - we have to check if the ia32-libs are installed if not, we install them with:

```
apt-get install ia32-libs
```

If again the device is not listed we try to stop and run the server again with the following (we have to be logged as root!):

```
cd /home/android-sdk/platform-tools/
./adb kill-server
./adb start-server
```

Exit the root and enter the shell of the device

```
./adb shell
```

We then create mounting point for the NAND memory :

```
mkdir /sdcard/nanda
```

and finally we mount the NAND:

```
mount -t vfat /dev/block/nanda /sdcard/nanda
```

Note : NAND mounting should be performed every time the device is restarted!

2.6.5. Downloading the default config file and script tool

Get the default 800x600 config file from:

<https://docs.google.com/open?id=0B7WHuNCASY8caVRIV29GdUVPX3M>

Open a new console (which will be used to edit the config file) - - then we download the following script:

https://docs.google.com/file/d/0B_DiNI-XEIr-MjQ4MmJhZGEMU1NS00MzllLWlZOWMtMzExODc5NTRkMGQ3/edit

We save both of the above files (both should be in the same folder)

Then we execute from the console :

```
chmod +x script
```

2.6.6. Applying the script and uploading the config

After we have edited the file as we wish we do:

```
./script A13_config_600x800.fex_ok
```

and then we push it on the device

```
path_to_android_sdk/android-sdk-linux/platform-tools/adb push A13_config_600x800.fexbin /sdcard/nanda/script.bin
```

2.6.7. Restarting the A13-OLinuXino

We go to the shell of the A13-OLinuXino board and

```
reboot
```

2.7 Configuration of hardware in the Debian image

Information on how to use the WIFI, Ethernet or GPIOs is available at the following web address:

https://www.olimex.com/wiki/Configuration_of_hardware_in_the_debian_image

CHAPTER 3: A13-OLINUXINO BOARD DESCRIPTION

3. Introduction to the chapter

Here you get acquainted with the main parts of the board. Note the names used on the board might differ from the names used below to describe them. For the actual names check the A13-OLinuXino board itself.

3.1 Layout (top view)

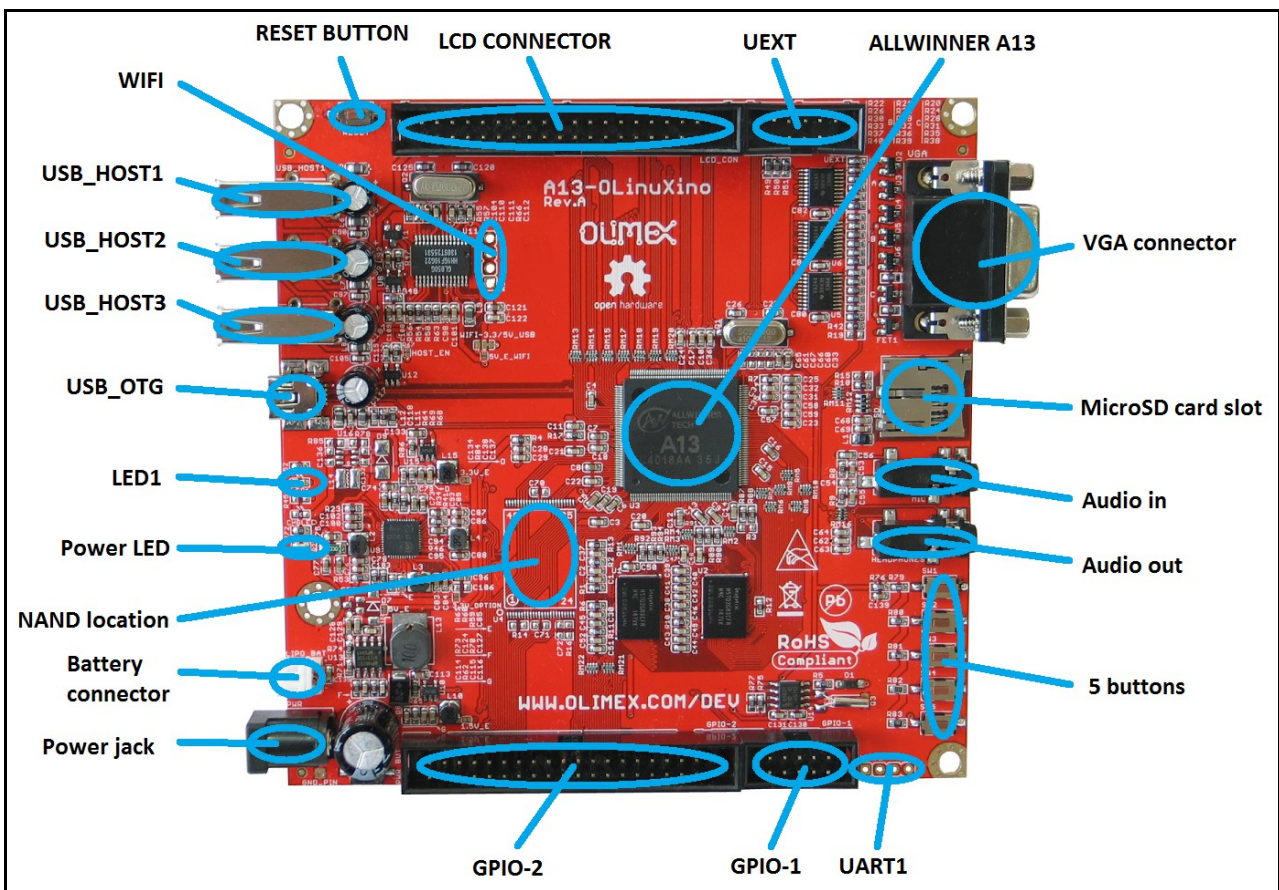

The picture above shows the initial revision of A13-OLinuXino. Note that the version of the board pictured does not have additional NAND memory nor WIFI module.

CHAPTER 4: THE ALLWINNER A13 MICROCONTROLLER

4. Introduction to the chapter

In this chapter is located the information about the heart of OLinuXino – its microcontroller. The information is a modified version of the datasheet provided by its manufacturers.

4.1 The microcontroller

- CPU/GPU
 - ARM Cortex-A8 Core
 - 32KB D-Cache/ 32KB I-Cache
 - 256KB L2 Cache
 - Mali-400 3-D Engine
- VPU
 - HD Video Decoding
 - 1920*1080@30fps
 - Support H.264, H.263, VC1, Mpeg1/2/4
 - Divx 3/4/5/6, Xvid, VP6/8, AVS etc
 - HD Video Encoding
 - Support encoding in H.264 format
 - Up to 1920*1080 at 30fps
- DPU
 - LCD Interfaces: CPU, RGB
- Memory
 - DDR2/DDR3: Up to 533MHz
 - 16 bits Data Bus
 - Memory capacity up to 512MB
 - MLC/TLC/SLC/EF-NAND
 - 2 flash chips, ECC 64-bit
 - Support NAND of 5xnm, 4xnm, 3xnm, 2xnm
 - Support NADN of Samsung, Toshiba, Hynix
- Peripherals
 - USB2.0 OTG, USB2.0 HOST
 - (OHCI/EHCI)

- SD Card V.3.0, eMMC V.4.2
- SPI, TWI and UART
- integrated Audio Codec
- CSI
- R-TP Controller
 - 4-wire resistive TP interface
 - 2 points and gesture detection
- Boot Devices
 - NAND Flash
 - SPI Nor Flash
 - SD Card
 - USB
- Powerful Acceleration
 - Graphic (3D, Mali400 MP)
 - VPU (1080P)
 - APU
 - E-Reader
- Ultra-low System Power Consumption
 - 15~20% lower than competitors
 - Smart Backlight: auto adjust backlight
 - acc. to the image display
- Package
 - eLQFP176

More information can be found on Allwinner's web site at the following web-address:
<http://www.allwinnertech.com/product/A13.html>

4.2 Block diagram

The block diagram is taken from Allwinner's datasheet.

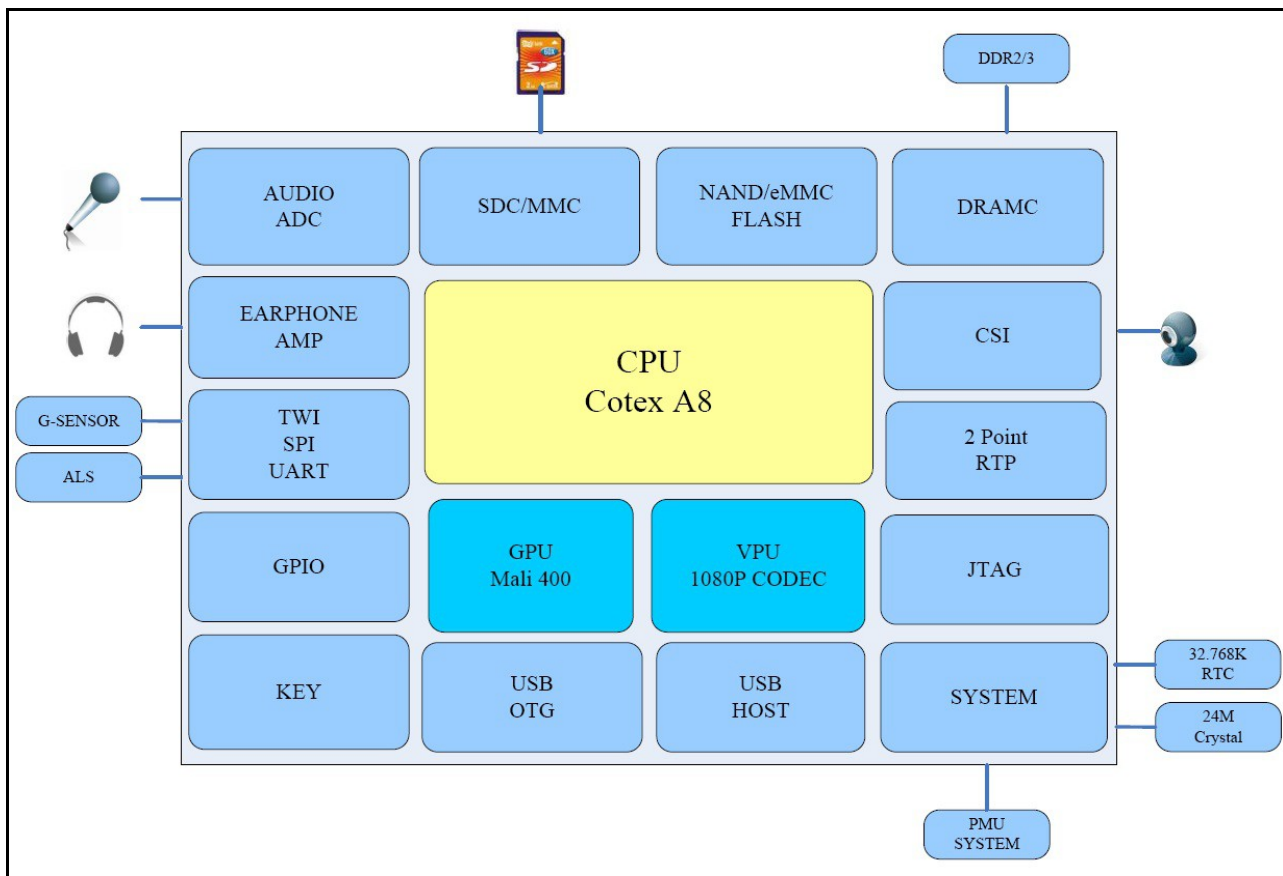

CHAPTER 5: CONTROL CIRCUITY

5. Introduction to the chapter

Here you can find information about reset circuit and quartz crystals locations, the power supply circuit is discussed.

5.1 Reset

The reset line is handled by the AXP209 (which is an enhanced single cell Li-battery and power system management IC that goes together with the Allwinner processor) and goes to processor pin 159 via R4(47k). The reset circuit is connected to button RESET, which means pressing RESET would perform a hardware reset on the board.

5.2 Clocks

24 MHz quartz crystal Q1 is connected to pins 91 and 92 of the A13 processor.

12 MHz quartz crystal Q2 is found at pins 6 and 7 of the GL850G (the USB controller).

32 768 kHz (RTC clock) quartz crystal Q3 is found connected to pins 1 and 2 of the RTC_MODULE (PCF8563T)

5.3 Power supply circuit

The power supply is handled mainly by AXP209 power management system, an Allwinner chip that goes together with the A13 processor. The power supply circuit of A13-OLinuXino allows flexible input supply from 6V to 16V. The minimum amperage suggested is 1A, and this threshold would rise if using all the three USB-HOSTs, a lot of GPIOs and LCD_con.

The board can also be powered by 3.7V Li-Po battery retaining its functionality or by USB (limiting the use of peripherals).

Important! Avoid disconnecting the power supply while Android or Linux is running, since that might corrupt the NAN memory (and the operating system files) and you will need to install the OS again (for Android install instructions check chapter 2.6. Hold the PWR_BUT and then navigate to shut down before disconnecting the supply.

CHAPTER 6: CONNECTORS AND PINOUT

6. Introduction to the chapter

In this chapter are presented the connectors that can be found on the board all together with their pinout and notes about them. Jumpers functions are described. Notes and info on specific peripherals are presented. Notes regarding the interfaces are given.

6.1 Communication with the A13

The chip has a built-in bootloader so everything you need for debugging is an USB cable. However there is a second option which is the male UART1 connector capable of delivering some information on the COM port of your computer. You can use USB-SERIAL-CABLE-F with the UART1 interface allowing you to connect to an USB port.

6.1.1 USB communication

The main way of communicating with the firmware of A13-OLinuXino is via the USB-OTG connector.

You will also need a software tool “LiveSuit” and a newer firmware image if you wish to upgrade the firmware. The “LiveSuit” tool may be downloaded from the A13 wiki page. The simple steps for upgrading the firmware via the bootloader are:

1. Start LiveSuit
2. Disconnect power supply cable and USB cable from A13-OLinuXino
3. Hold “Home” button
4. Connect the board to the power supply and the computer via the USB-OTG
5. Release “Home” button
6. You will be asked for drivers, point the installer to the LiveSuit folder which contains drivers for the bootloader
7. Choose the image in the LiveSuit
8. Update and don't disconnect the board

The three USB type A hosts are wired to a USB-controller GL850G which is an advanced version hub solution fully complying with Universal Serial Bus Specification Revision 2.0. GL850G has proven compatibility, lower power consumption figure and better cost structure above all USB2.0 hub solutions worldwide.

6.1.2 UART1 interface

The UART interface might be used for COM communication. You can use our USB-SERIAL-CABLE-F for debugging via the UART1 or UART0. Note that in both cases the connectors are named at the bottom of the board.

Depending on the revision of the board it is possible to have 1xUART1 or 1xUART0 + 1xUART1.

If having a board with 1xUART1 (board revision B, A13-OlinuXino-WIFI-DEV) the table with the signals can be found below:

UART1		
Pin #	Signal Name	Processor Pin #
1	3.3V	-
2	SDC0_SCK	110
3	SDC0_DATA3	112
4	GND	-

Consider the above table when connecting the USB-SERIAL-CABLE-F according to the wire color code. If having A13-OLinuXino with 1xUART0 and the table with the signals can be found below:

UART0			UART1		
Pin #	Signal Name	Processor Pin #	Pin #	Signal Name	Processor Pin #
1	3.3V	-	1	3.3V	-
2	SDC0_SCK	110	2	UART1_TX	152
3	SDC0_DATA3	112	3	UART1_RX	151
4	GND	-	4	GND	-

Consider the above table when connecting the USB-SERIAL-CABLE-F.

Notice that UART0 data lines are multiplexed with the SD-CARD.

Notice that UART1 data lines are multiplexed with the UART pins in the UEXT connector.

6.2 SD/MMC slot

The microSD card slot is a standard 8pin connector.

The SD card can be used for booting the operating system for A13-OLinuXino. It is suggested to have an SD card with a proper Linux/Android image especially if you have ordered a version of the board without NAND memory.

We have tested a number of microSD cards on the OLinuXino boards and all of them worked fine regardless manufacturer or capacity. However, keep in mind that some of the lower quality microSD cards might draw too much current from the slot which might cause power-state problems. If you suspect the microSD card is causing problems please try using another one of better quality for better results.

microSD card connector		
Pin #	Signal Name	Processor Pin #
1	DAT2/RES	113
2	SDC0_DATA3	112
3	SDC0_CMD	111
4	VDD	-
5	SDC0_SCK	110
6	VSS	-
7	SDC0_DATA0	108
8	SDC0_DATA1	107

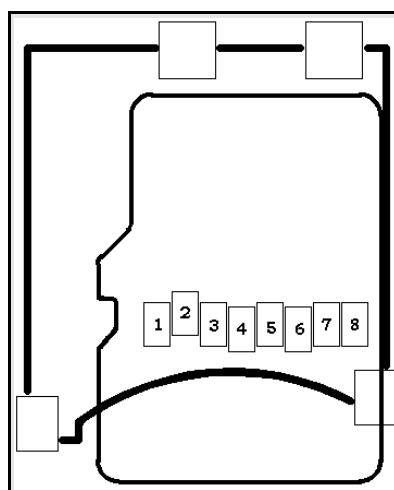

When removing the card, please make sure that you release it from the connector by pushing and NOT by pulling the card directly (this can damage both the connector and the microSD card).

6.3 UEXT module

A13-OLinuXino has an UEXT connector and can connect with Olimex's UEXT modules.
For more information on UEXT please visit:

<https://www.olimex.com/Products/Modules/UEXT/resources/UEXT.pdf>

UEXT connector		
Pin #	Signal Name	Processor Pin #
1	3.3V	-
2	GND	-
3	UART1_TX	152
4	UART1_RX	151
5	TWI2_SCK	161
6	TWI2_SDA	160
7	SPI2_MISO	117
8	SPI2_MOSI	116
9	SPI2_CLK	115
10	SPI2_CS0	114

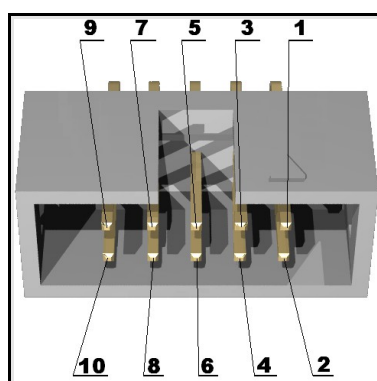

The UEXT pinout is also printed at the bottom of the board under the connector.

Notice that UART1 data lines are multiplexed with the UART pins in the UEXT connector.

6.4 GPIO-1 (General Purpose Input/Output) 10pin connector

The GPIO connector numbers are printed at the bottom of the board for your convenience.

GPIO-1		
Pin #	Signal Name	Processor Pin #
1	5V	-
2	GND	-
3	3.3V	-
4	GND	-
5	RESET_N	159
6	NMI_N	158
7	PIN0	-
8	PIN3	-
9	PIN1	-
10	PIN2	-

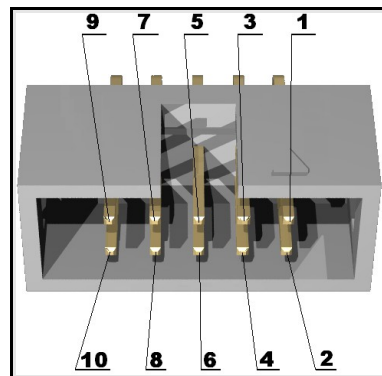

PIN0, PIN1, PIN2 and PIN3 are connected to the power regulator module AXP209.

6.5 GPIO-2 (General Purpose Input/Output) 40pin connector

The GPIO pins are led out on a separate 40pin connector. They allow the user to attach additional hardware, check readings or perform hardware debug. The GPIO-2 connector numbers are printed at the bottom of the board for your convenience.

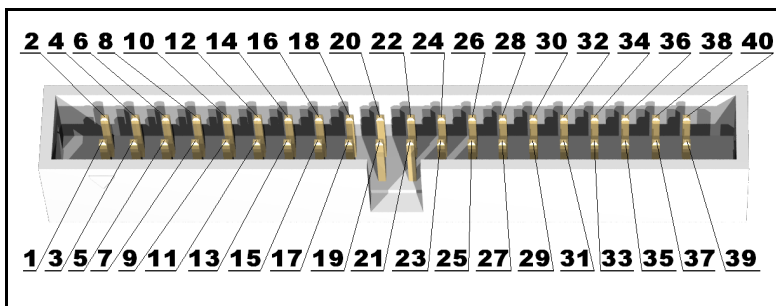

GPIO-2 connector					
GPIO Pin#	Signal Name	Processor pin#	GPIO Pin#	Signal Name	Processor pin#
1	5V	-	2	GND	-
3	3.3V	-	4	GND	-
5	PIN4/TWI0-SCK	101	6	PIN39/USBH_EN	14
7	PIN5/TWI0-SDA	102	8	PIN38/VGA_DIS	13
9	PIN6	103	10	PIN37/LED1	12
11	PIN7	150	12	PIN36	125
13	PIN8	104	14	PIN35	124
15	PIN9	10	16	PIN34	123
17	PIN10/TWI1-SCK	105	18	PIN33	122
19	PIN11/TWI1-SDA	106	20	PIN32	121
GPIO Pin#	Signal Name	Processor pin#	GPIO Pin#	Signal Name	Processor pin#
21	PIN12/NWE	8	22	PIN31	120
23	PIN13/NALE	7	24	PIN30	119
25	PIN14/NCLE	6	26	PIN29	118
27	PIN15/NCE1	3	28	PIN28/NDQS	162
29	PIN16/NCE0	2	30	PIN27/NDQ7	165
31	PIN17/NRE	1	32	PIN26/NDQ6	166
33	PIN18/NRB0	176	34	PIN25/NDQ5	167
35	PIN19/NRB1	175	36	PIN24/NDQ4	168
37	PIN20/NDQ0	174	38	PIN23/NDQ3	170
39	PIN21/NDQ1	172	40	PIN22/NDQ2	171

6.6 LCD_CON 40pin connector

The LCD_CON pins are led out on a separate 40pin connector for the ease of connecting an LCD. We have tested the ability of the board to interact with such a display. They allow the user to attach additional hardware, check readings or perform hardware debug. The LCD_CON connectors connector numbers are print at the bottom of the board for your convenience.

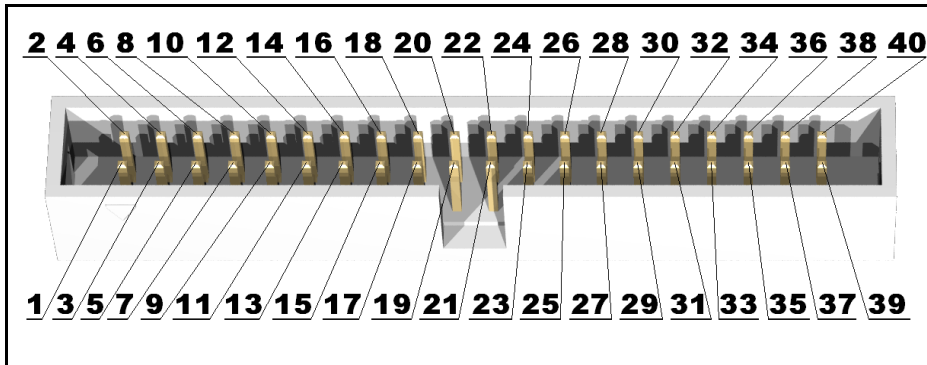

LCD_CON connector					
GPIO Pin#	Signal Name	Processor pin#	GPIO Pin#	Signal Name	Processor pin#
1	5	-	2	GND	-
3	3.3	-	4	GND	-
5	LCD_D18	135	6	LCD_D18	135
7	LCD_D18	135	8	LCD_D19	134
9	LCD_D20	133	10	LCD_D21	132
11	LCD_D22	131	12	LCD_D23	130
13	LCD_D10	141	14	LCD_D10	141
15	LCD_D10	141	16	LCD_D11	140
17	LCD_D12	139	18	LCD_D13	138
19	LCD_D14	137	20	LCD_D15	136
21	LCD_D2	148	22	LCD_D2	148
23	LCD_D2	148	24	LCD_D3	147
25	LCD_D4	146	26	LCD_D5	145
27	LCD_D6	144	28	LCD_D7	143
29	LCD_HSYNC	127	30	LCD_VSYNC	126

31	LCD_CLK	129	32	LCD_DE	128
GPIO Pin#	Name	Processor pin#	GPIO Pin#	Name	Processor pin#
33	PIN7	150	34	PIN8	104
35	PIN9	10	36	PIN6/PWM0	109
37	TPX1	89	38	TPX2	87
39	TPY1	90	40	TPY2	88

6.7 PWR Jack

The power jack used is the typical 2.5mm one used by Olimex in most of our products. You should provide between 6 and 16 volts @ 1.5A maximum to the board.

Pin #	Signal Name
1	Power Input
2	GND

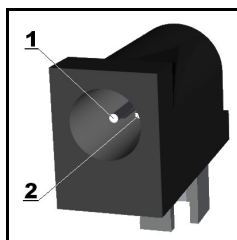

More info about the power supply can be found in chapter 5 of this manual

6.8 Headphones and microphone connector

Standard audio jack and phone jack are mounted for the audio interfacing.

Microphone/Audio out connector		
Pin#	SIGNAL NAME	Processor Pin#
2	L channel	74
3	R channel	78
5	HPCOM	GND pins

The headphones resistance is 32 Ohms! The mic is connected to pins 84 and 85 of the A13 chip.

6.9 Battery connector

When using the battery connector keep in mind that it is an energy solution that wouldn't be able to power the board and all the peripherals. The voltage of a 3.7V LIPO battery would be enough to power the processor and the memory but won't be enough to power external touchscreen LCD.

Pin #	Signal Name
1	VBAT
2	GND

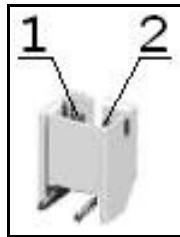

The pins are also print at the bottom of the board under the connector.

6.7 VGA video connector

The female DB15 connector is used for video output on a monitor. At the moment the maximum achieved resolution is 800x600 due to limited maximum frequency and the lack of integrated video controller in the chip.

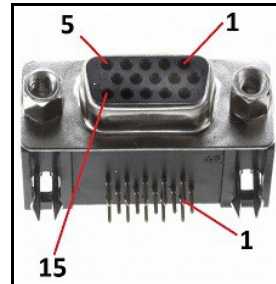

VGA connector			
GPIO Pin#	Signal Name	GPIO Pin#	Signal Name
1	VGA_R	2	VGA_G
3	VGA_B	4	Not Connected
5	GND	6	GND
7	GND	8	GND
9	GND	10	GND
11	Not Connected	12	Not Connected
13	VGA_HSYNC	14	VGA_VSYNC
15	Not Connected	16	Not Connected

6.8 Jumper description

Please note that all the jumpers on the board are SMD type. If you feel insecure of your soldering/cutting technique it is better not to try to adjust the jumpers. The only really important jumper on the board is CE_NAND_E, which needs to be closed if you have board variant with NAND flash memory but you wish to boot OS from SD card.

6.8.1 CE_NAND_E

When cut this board disconnects the NAND flash. Note that it is not a requirement to boot from the SD card since the processor has a routine of detecting such.

The default position is closed.

6.8.2 3.3V_OPTION, 1.5V_E

Both jumpers provide a test pad during production and debugging checking the supply voltages. It is not recommended to change their default positions.

The default positions are closed.

6.8.3 5V_E

The jumper provide a test pad during production and debugging checking the supply voltages. It is not recommended to change its default position. It is also useful if you remove the whole battery part of the board.

The default position is open.

6.8.4 HOST_EN, 5V_E_WIFI, WIFI-3.3V/5V_USB

These jumper provide options to setup the WIFI module to work on 3.3V, and/or the USB host to work on 3.3V. It is strongly not recommended to change the default positions, since then they will be directly powered from source which might cause faults of USB devices when disconnecting them from the hub.

Default positions are:

HOST_EN – open;

5V_E_WIFI – open;

WIFI-3.3V/5V_USB in 5V_USB position.

6.9 Additional hardware components

The components below are mounted on OLinuXino but are not discussed above. They are listed here for completeness:

Reset button - used to reset the board

2 x 2Gb (512M x 8 bit) DDR3 SDRAM - the exact memory used in the first revisions of the board is hynix H5TQ2G83CFR-H9C

1 x 32Gb (4096M x 8 bit) NAND FLASH – the exact memory is hynix H27UBG8BTR – only present in A13-OLinuXino-WIFI

LED1 + CHLED + PWR_LED – GPIO LED + battery charger activity LED + power-on LED

CHAPTER 7: SCHEMATICS

7. Introduction to the chapter

In this chapter are located the schematics describing logically and physically A13-OLinuXino.

7.1 Eagle schematic

OLinuXino schematic is visible only for reference here. You can also find it on the OLinuXino's GitHub repository: <https://github.com/OLIMEX/OLINUXINO>. They are located in HARDWARE section.

You are allowed to view and edit the schematics as long you keep them free and you mention the source address (e.g. www.olimex.com).

The EAGLE schematic is situated on the next page for quicker reference.

Note that A13-OLinuXino-WIFI has all the components shown in the schematics. The stripped down version (A13-OLinuXino, without the -WIFI part) lacks two components: the NAND memory and the embedded WIFI module RTL8188CU. To reduce this document's size only one of the schematics is listed.

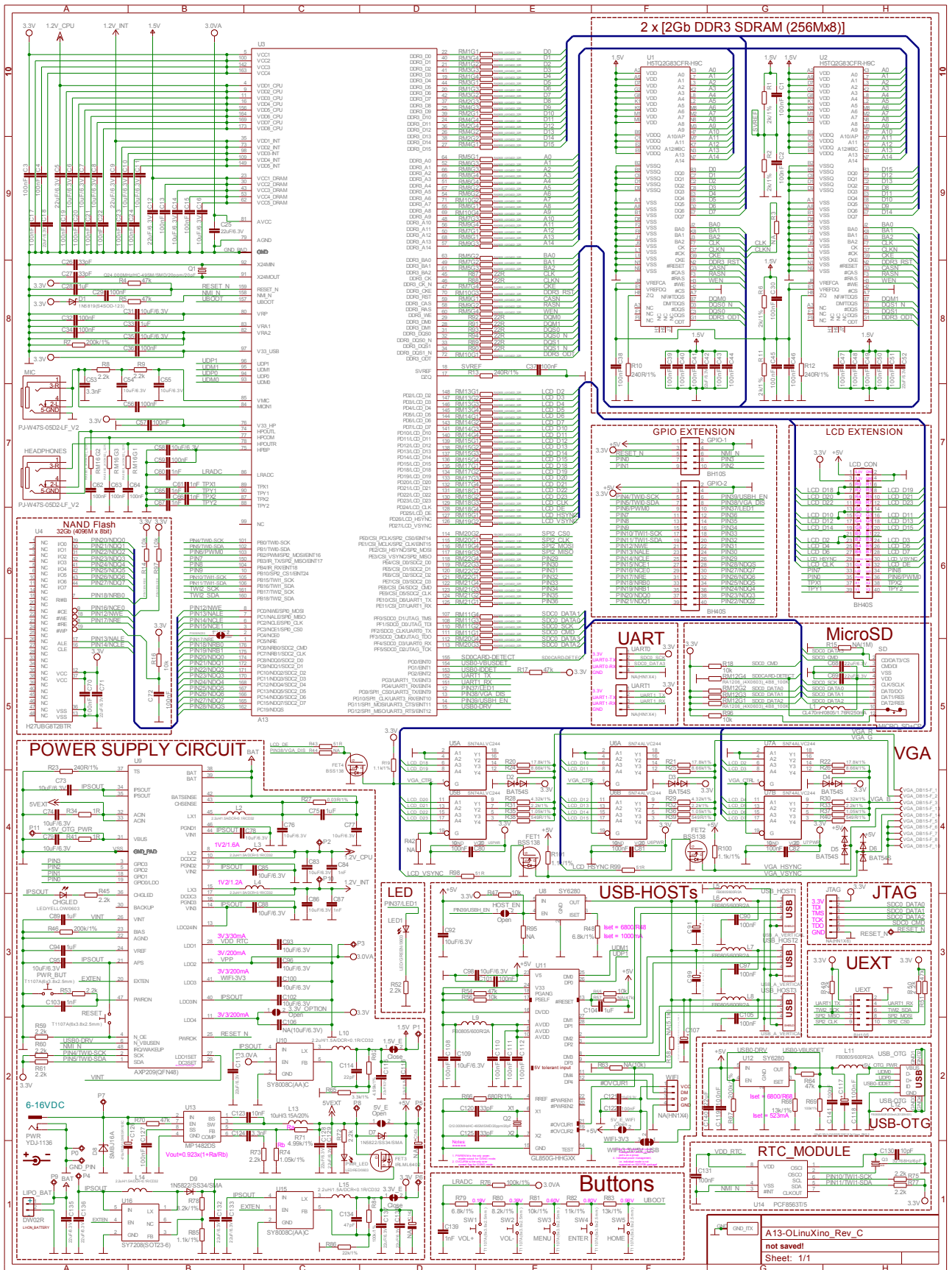

A13-OLinXino_Rev_C
 not saved!
 Sheet: 1/1

7.2 Physical dimensions

Note that all dimensions are in mils.

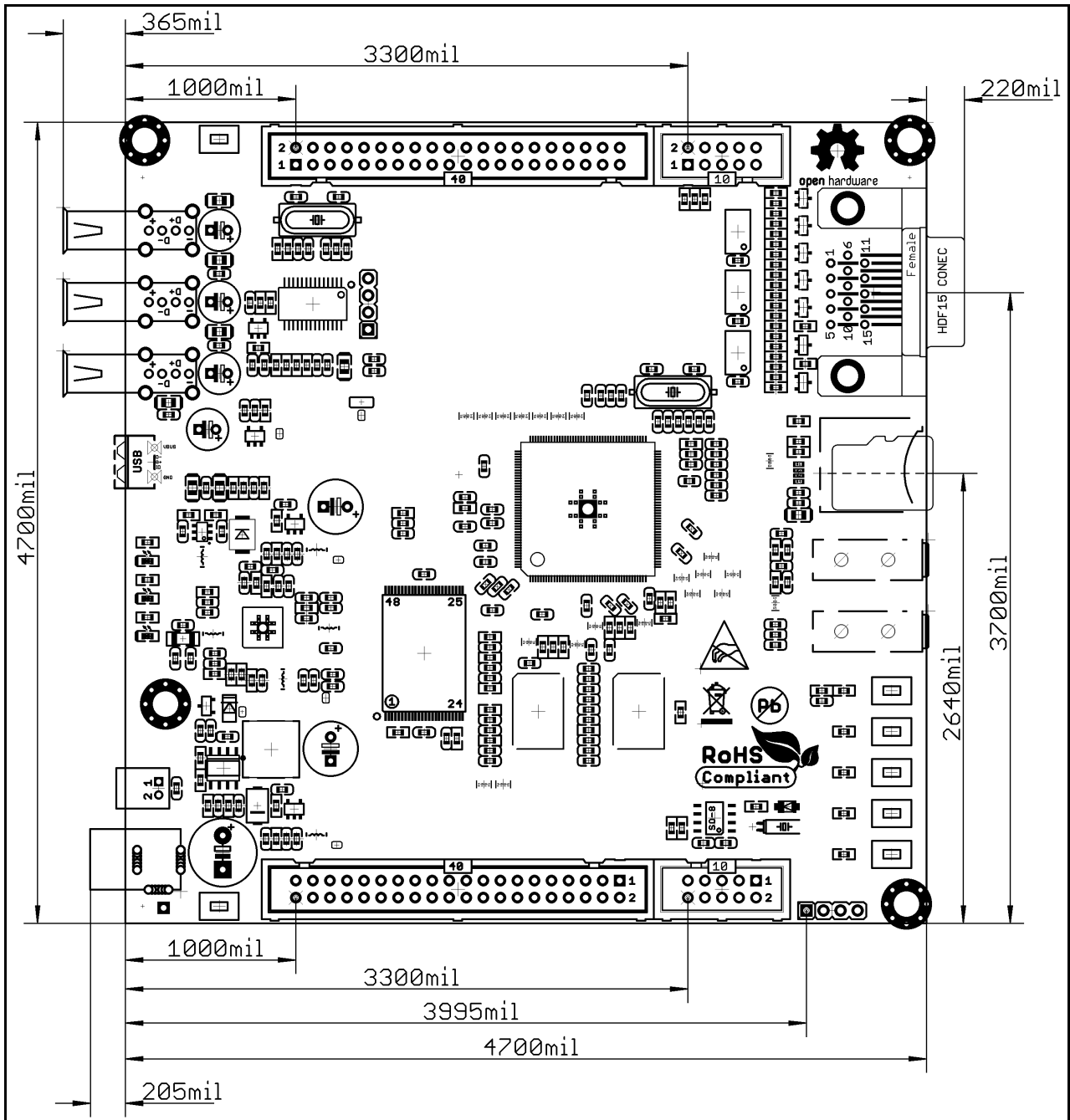

The three highest elements on the board in order from the tallest to the shortest are: capacitor C126 – 650mils, the three USB hosts – 500mils, the VGA connector - 475mils

CHAPTER 8: REVISION HISTORY AND SUPPORT

8. Introduction to the chapter

In this chapter you will find the current and the previous version of the document you are reading. Also the web-page for your device is listed. Be sure to check it after a purchase for the latest available updates and examples.

8.1 Document revision

Revision	Changes	Modified Page#
A, 19.09.12	Initial Creation	All
B, 21.09.12	Page 9 - Fixed several errors in voltage requirements and power consumption	9
C, 24.09.12	Pages 8, 9 - Fixed a typo of the wattage required Page 11 - Added info how to change the configuration of the Android image	8, 9, 11
D, 26.09.12	Pages 9, 19 - added important note about powering down Pages 13, 14 - changed the default config file	9, 13, 14, 19
Continues on the next page		

Continued from the previous page		
Revision	Changes	Modified Page#
E, 31.10.12	<p>Pages 9, 10, 37 - added info about Android images</p> <p>Page 29 - fixed erroneous information about CE_NAND_E</p> <p>Various pages - made it clear that the standard version lacks NAND and WIFI</p>	9, 10, 29, 37
F, 21.03.13	<p>Pages 9, 19 - added info about LiveSuit and cleared the instructions</p> <p>Page 29 - fixed erroneous memory descriptions</p> <p>Pages 20, 22 - added some multiplexing notes for clarity</p> <p>Pages 33, 34- updated board revisions</p> <p>Various pages- updated several links</p>	9, 19, 20, 22, 29 33, 34

8.2 Board revision

Remember to check the schematics and the board design files to compare the differences.

Revision	Notable Changes
B	Initial release of the board
C	<ol style="list-style-type: none">1. Fixed the VGA problem with development edition;2. changed UART1 to UART0 and added new UART1;3. added SMD jumper to be able to disable CS if you wish to boot from SD card in future;4. JTAG signals are on led to pads;5. added test pads for the voltage of all regulators;6. moved couple of elements for better distance between each other
D	<ol style="list-style-type: none">1. Removed resistor matrices, except the ones near DDR3 memories - to lower fault rates2. Added header NA(HN1X2) so you can power only the RTC from external battery3. BAT54C is added to allow RTC powering either from VDD_RTC or 3.0V_BAT
E	<ol style="list-style-type: none">1. Added BAT54C after Rx to UART1 connector2. Added 100k pull-up resistor on the RX line3. Changed wrong prints of the revision and the Olimex web-site4. Some libraries updated and some component prints removed due to space restrictions

8.3 Useful web links and purchase codes

The web page you can visit for more info on your device is

<https://www.olimex.com/Products/OLinuXino/A13/A13-OLinuXino-WIFI/>.

A place for general questions, FAQ or friendly talk check our forums:

<https://www.olimex.com/forum/>

Links to some of the ready images are available in the wiki: <https://www.olimex.com/wiki/A13-OLinuXino>

You can get the latest updates on the software at: <https://github.com/OLIMEX/OLINUXINO>.

ORDER CODES:

A13-OLinuXino-WIFI – the full version of A13-OLinuXino with added NAND memory (Android image) and MOD-WIFI_RTL8188

A13-OLinuXino – the lite version of A13-OLinuXino with no external NAND and no embedded internet interface

USB-SERIAL-CABLE-F - USB serial console cable for connecting to UART1

SY0612E - power supply adapter 12V/0.5A for A13-OLinuXino and A13-OLinuXino-WIFI

BATTERY-LIPO1400mAh – battery capable of powering A13-OLinuXino-WIFI for a couple of hours (4+ hours standby with WiFi on)

How to order?

You can order directly from our online shop or from any of our distributors. The list of distributors is found here: <https://www.olimex.com/Distributors/>.

Check <https://www.olimex.com/> for more info.

8.4 Product support

For product support, hardware information and error reports mail to: support@olimex.com. Note that we are primarily a hardware company and our software support is limited.

Please consider reading the paragraph below about the warranty of Olimex products.

Warranty and returns:

Our boards have lifetime warranty against manufacturing defects and components.

During development work it is not unlikely that you can burn your programmer or development board. This is normal, we also do development work and we have damaged A LOT of programmers and boards during our daily job so we know how it works. If our board/programmer has worked fine then stopped, please check if you didn't apply over voltage by mistake, or shorted something in your target board where the programmer was connected etc. Sometimes boards might get damaged by ESD shock voltage or if you spill coffee on them during your work when they are powered.

Please note that warranty do not cover problems caused by improper use, shorts, over-voltages, ESD shock etc.

If the board has warranty label it should be not broken. Broken labels void the warranty, same applies for boards modified by the customer, for instance soldering additional components or removing components - such boards will be not be a subject of our warranty.

If you are positive that the problem is due to manufacturing defect or component you can return the board back to us for inspection.

When we receive the board we will check and if the problem is caused due to our fault and we will repair/replace the faulty hardware free of charge, otherwise we can quote price of the repair.

Note that all shippings back and forth have to be covered by the customer. Before you ship anything back you need to ask for RMA. When you ship back please attach to it your shipping address, phone, e-mail, RMA# and brief description of the problem. All boards should be sent back in antistatic package and well packed to prevent damages during the transport.